

DNP

DIGITAL PHOTO PRINTER

DP-DS820

DP-DS820 (A)

Printer Driver User's Manual

For Windows 7, 8, 10

- **Safety precautions**

Before you use the printer, carefully read the User's manual to ensure that you use the printer correctly. Be aware that the content complies with the standards at the time the User's manual section related to safety, including usage and safety precautions, was created.

- **Modifications**

For product safety, it is prohibited to modify the DP-DS820/DP-DS820 (A) printer, DP-DS820/DP-DS820 (A) printer driver, and CD contents.

- **Copyright**

The copyrights, trademark rights, and other intellectual property rights related to documents and programs included with this product are the property of Dai Nippon Printing Co., Ltd. and other rights holders. You cannot copy and use these items without the permission of Dai Nippon printing Co., Ltd. except where permitted by applicable laws.

Microsoft and Windows are trademarks or registered trademarks of Microsoft Corporation in the United States and in other countries.

LEADTOOLS Copyright (C) 2008 LEAD Technologies, Inc.

- **About the product destination**

You cannot resale/use the DP-DS820 without destination number (A) in the U.S.

Table of contents

Chapter 1 Installation	1
1.1 Prepare the printer and computer	2
1.2 Install the driver package	2
1.3 Install the printer driver	6
1.4 Install drivers for unspecified devices	10
Chapter 2 Properties	13
2.1 Open the printer properties	13
2.2 Print settings functions	15
2.2.1 Layout	15
2.2.2 Advanced options	16
2.2.3 Paper/Quality	22
2.2.4 Option	22
2.2.5 Color Adjustment	24
2.2.6 Printer information	25
2.3 Default values for settings	27
2.4 Color management	28
2.5 Print Area	29
2.6 Orientation	30
Chapter 3 Update the driver	31
Chapter 4 Delete the driver	34
4.1 Automatic deletion of printer drivers	34
4.2 Manual deletion of printer drivers	35

Main additional functions from previous

- **Add Rewind Print function (limited to applicable countries)**
The Rewind Print function reduces consumption of the ribbon for the sizes (8x4), (8x5), (8x6), and A5 Format.
For details, see "The rewinding print function" in 2.2.2 Advanced options.
- **Added printer information**
Added a printer information function to display, for example, printer information and the status/number of printable copies on the driver screen.
For details, see 2.2.6 Printer information.
- **Added language settings**
Added a function to change the display language for the following print settings: Advanced options-Printer functions, Option, Color Adjustment, and Printer Info.
For details, see 2.2.4 Option.

Chapter 1 Installation

Installation procedure

The installation procedure is made up of three steps.
The details of each step are explained below.

Step 1 Prepare the printer and computer → "1.1 Prepare the printer and computer"

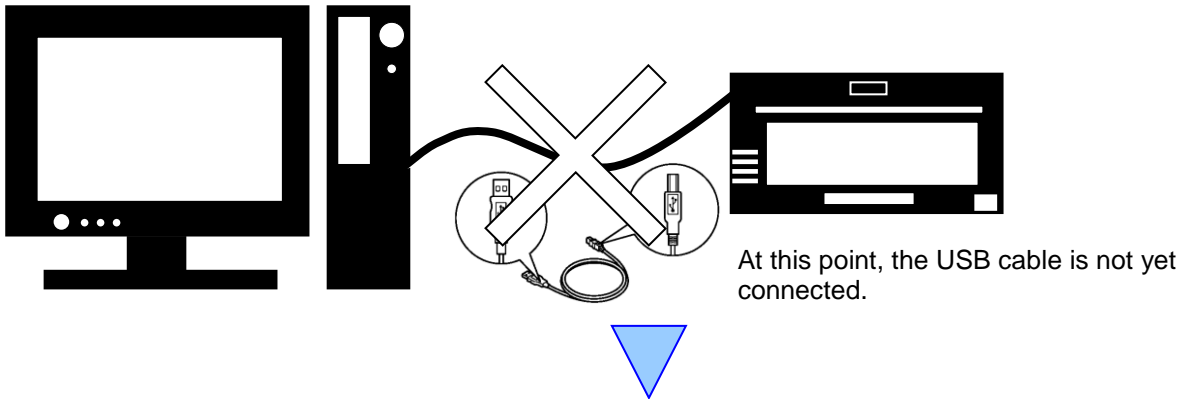

Step 2 Install the driver package → "1.2 Install the driver package"

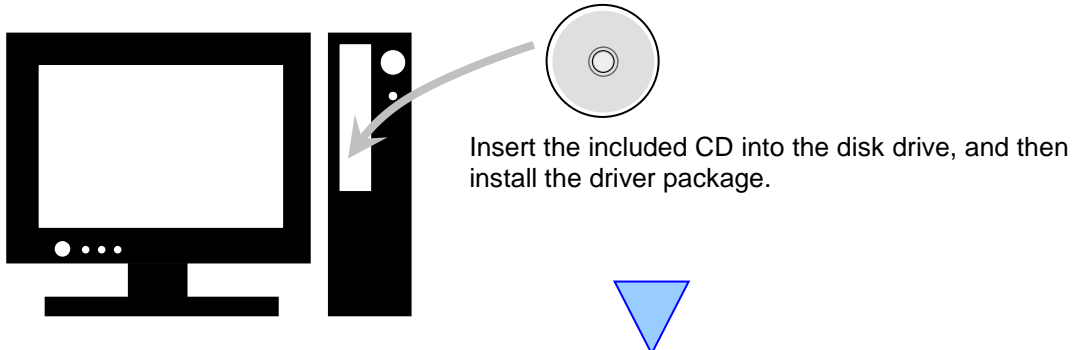

Step 3 Install the printer driver → "1.3 Install the printer driver"

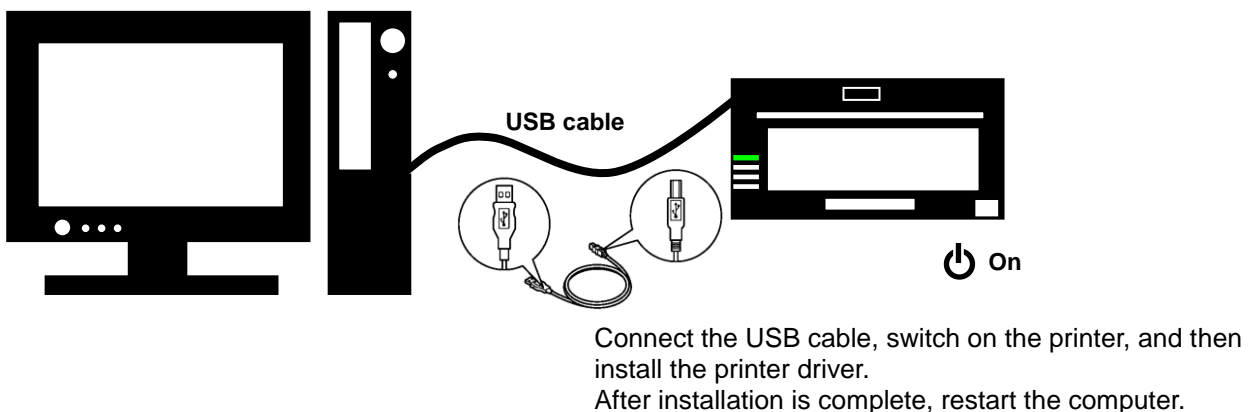

1.1 Prepare the printer and computer

Make sure that the printer power is off.

Prepare a USB cable. However, do not use the USB cable to connect the printer and computer at this time.

Log in to Windows as an administrator. The following explanation presumes that the operations are carried out with administrator privileges.

1.2 Install the driver package

Insert the included CD into the disc drive.

Open Windows Explorer, and then click the corresponding drive.

(If AutoPlay is enabled, select Open folder to view files using Windows Explorer.)

(If AutoPlay is enabled in Windows 8 and 10, a message appears stating "Tap to choose what happens with this disk". Click the message and select "Open folder to view files Windows Explorer")

Select one of the following folders on the included CD. *Select the folder for your usage environment.

CD drive:\\DP-DS820_Driver

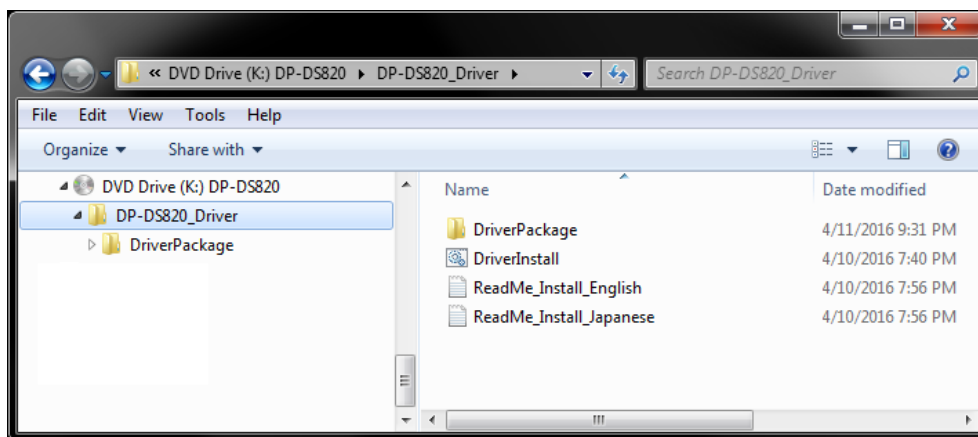

Figure 1.2.1 Driver Package folder

In the selected folder, double click the following file: DriverInstall.CMD. (Depending on your usage environment, the .CMD extension may not be displayed.)
 The driver package installer appropriate for your operating system (32-bit or 64-bit) is selected automatically.

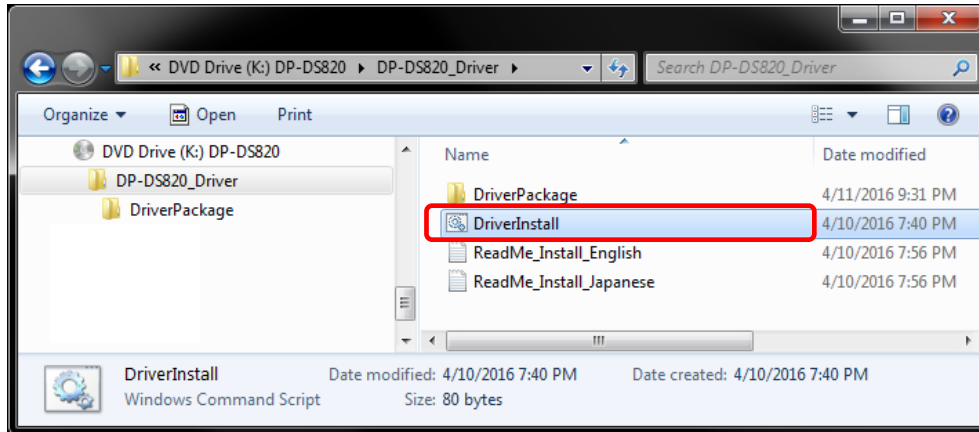

Figure 1.2.2 Installation file

When you start the installer, a window appears for selecting the language that will be used during the installation.
 After you select the language to use, click “OK”.

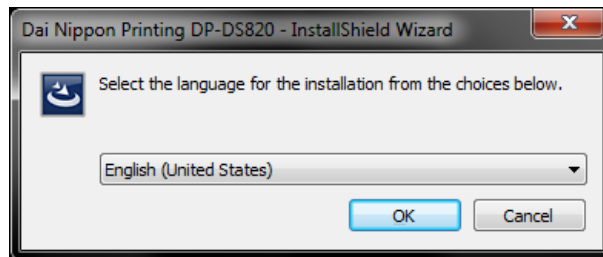

Figure 1.2.3 Language selection screen

Click “Next >” when the Installation Wizard screen appears.



Figure 1.2.4 Installation Wizard start screen

Click "Install" when the installation is ready.

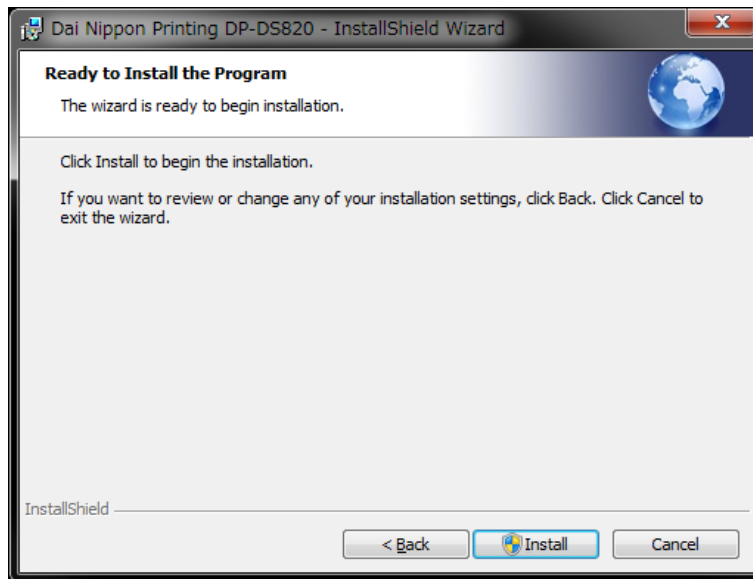

Figure 1.2.5 Installation start confirmation screen

When the installation starts, a screen appears that shows the installation status.

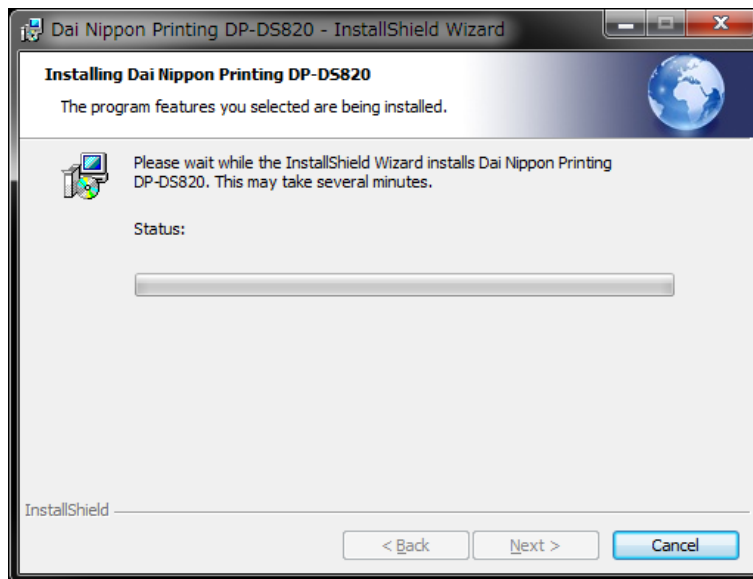

Figure 1.2.6 Installation status screen

When a User Account Control dialog box appears, click Yes.

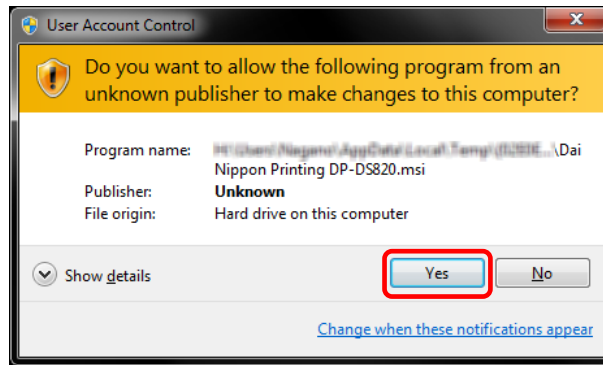

Figure 1.2.7 User Account Control

Click "Install" when the Windows Security confirmation display appears.

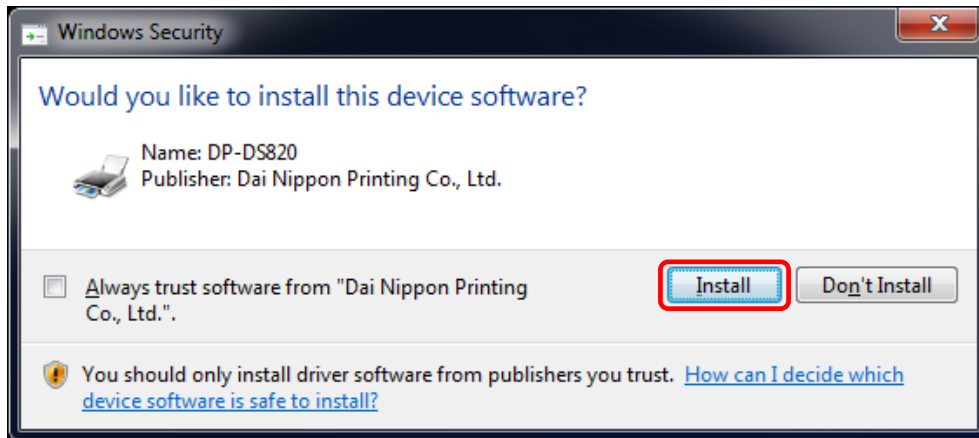

Figure 1.2.8 Windows Security confirmation

Installation of the driver package starts. Wait until installation finishes. Click "Finish" when the Installation Wizard completion screen appears.

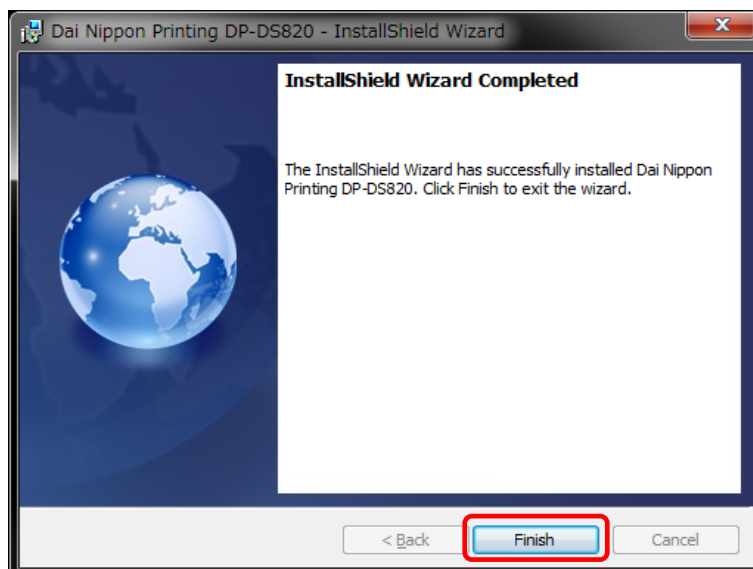

Figure 1.2.9 Finish of Installation Wizard

1.3 Install the printer driver

Use the USB cable to connect the printer and computer, and then switch on the power of the DP-DS820 printer. After the printer is recognized, installation of the driver starts.

*For the connection, see the User's manual of the DP-DS820.

If driver installation starts, the following message appears in the taskbar: "Installing device driver software".
In Windows 8 and 10, this message does not appear. Proceed to page 7.

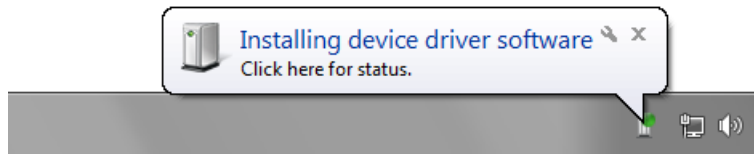

Figure 1.3.1 Driver installation message

If you click on this message, the Install driver software screen appears and displays the installation status of the driver. If Close is clicked, this screen closes.

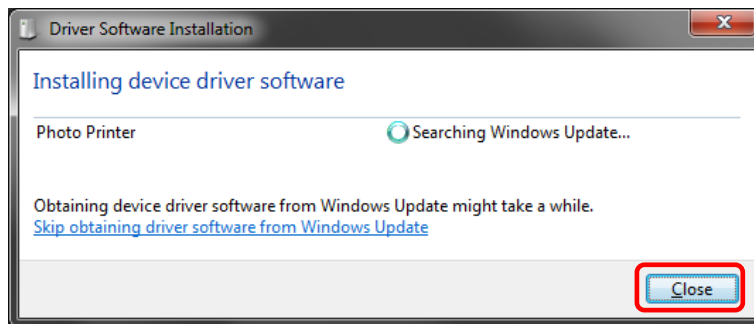

Figure 1.3.2 Installing the driver software

*About the "Skip obtaining driver software from Windows Update" option

If your operating system is configured to obtain driver software from Windows Update, it may take time for installation to complete because the process searches for drivers from Windows Update first. You can reduce the time until the completion of installation by choosing to skip obtaining driver software from Windows Update. (Depending on your operating system, it may take some time until installation is complete.)

From the Driver Software Installation dialog box, click "Skip obtaining driver software from Windows Update".

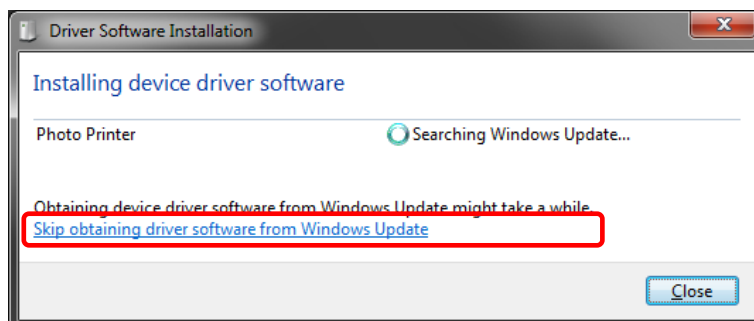

Figure 1.3.3 Option to skip obtaining driver software from Windows Update

A confirmation dialog box appears. Click Yes.

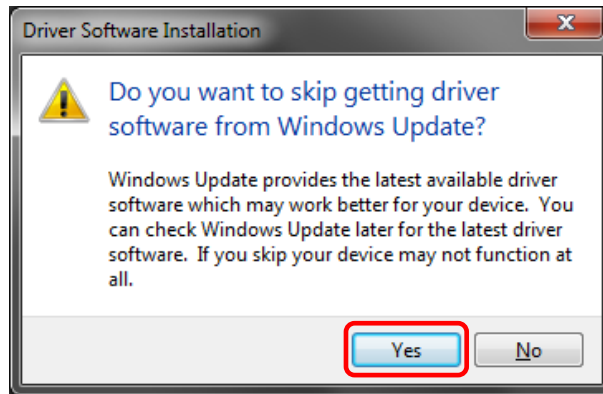

Figure 1.3.4 Confirmation to skip getting driver software from Windows Update

Soon after installation starts, a message appears in the taskbar stating “Your device is ready to use”, and then printer driver installation finishes.

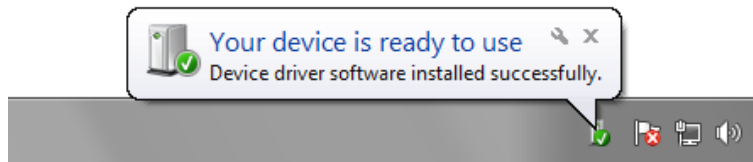

Figure 1.3.5 Installation complete message

If you click on the message, the Driver Software Installation dialog appears, and the “Your device is ready to use” message appears. Click Close.

(If the Driver Software Installation screen is open when installation starts, the abovementioned taskbar message is not displayed.)

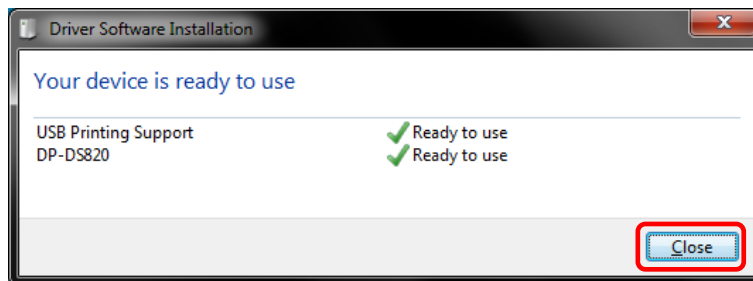

Figure 1.3.6 Completion of driver software installation

Click "Start", and then click "Control Panel" to open the Control Panel.

In Windows 8, right click the Start screen. In the bottom right area, select All Apps, and then select Control Panel.

In Windows 10, right click the Start. and then click "Control Panel" to open the Control Panel.

In Control Panel, click "View devices and printers".

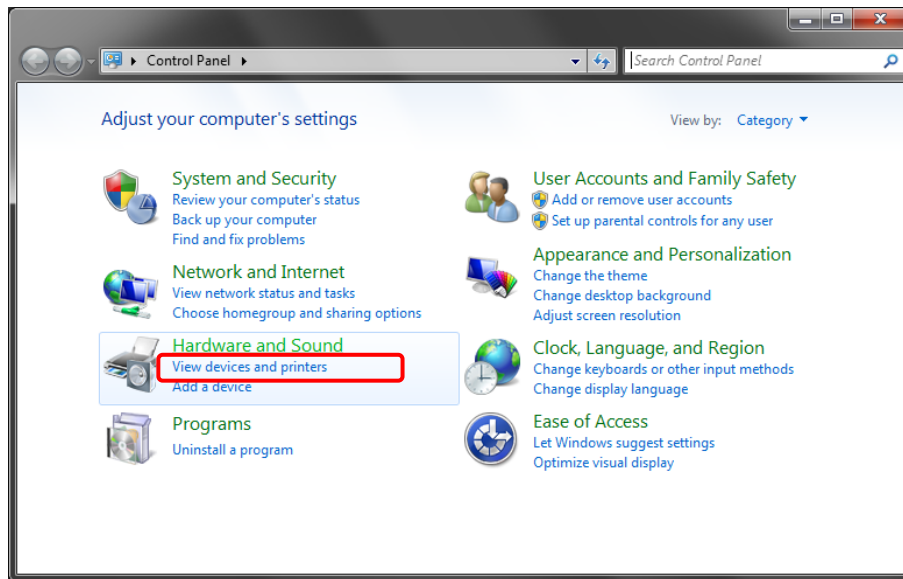

Figure 1.3.7 Control Panel

In Devices and Printers, make sure that "DP-DS820" is present.

Note: In Windows 8 and 10, when the printer is offline (the printer is not on and connected), the DP-DS820 icon is not displayed.

This completes installation of the DP-DS820 printer driver.

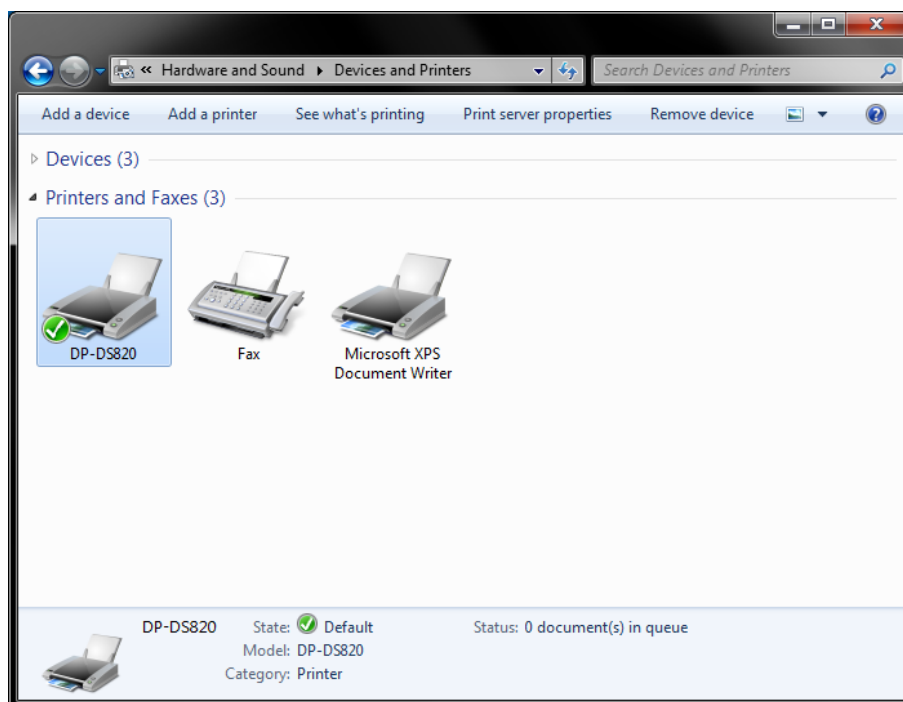

Figure 1.3.8 Devices and Printers screen

After the installation of the printer driver is complete, always restart the computer.

When it was not possible to install the DP-DS820 printer driver correctly, the following message appears in the taskbar: Device driver software was not successfully installed.

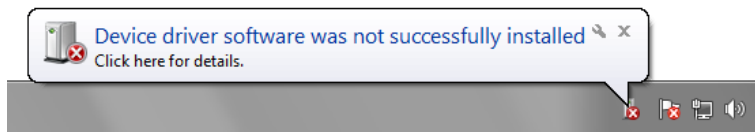

Figure 1.3.9 Message indicating that the driver was not installed

If you click on this message, the Install driver software screen appears and displays the message "Device driver software was not successfully installed". Click Close.

(If the Driver Software Installation screen is open when installation starts, the abovementioned taskbar message is not displayed.)

When the driver could not be installed correctly, see the next section, 1.4, "Install drivers for unspecified devices", and then install the printer driver.

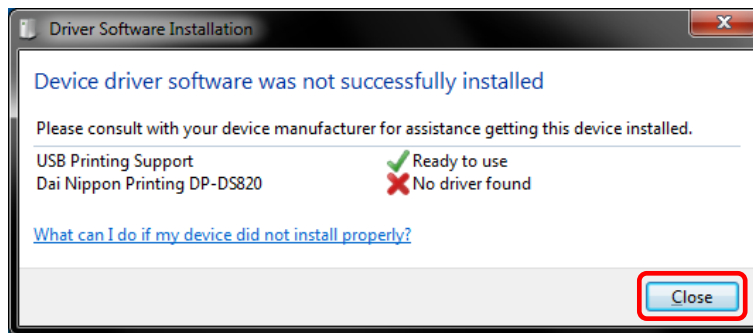

Figure 1.3.10 When the driver was not installed correctly

1.4 Install drivers for unspecified devices

If you connect a printer that is on to the computer before installing the driver package, a device is created under "Unspecified" in Devices and Printers. In such a case, use the following method to install the printer driver.

Furthermore, use the following method to install the printer driver if you use the standard installation procedure (install the driver package, connect the printer, and then install the printer driver), but the driver is not installed correctly, and a device is created under "Unspecified".

1. Install the driver package

When the driver package has not yet been installed, install it by following the procedure in 1.2, "Install the driver package".

If you install the driver package, installation of the printer driver for the unspecified device completes it automatically.

2. Installing a driver for an unspecified device

In Devices and Printers, under Unspecified, right click on "Photo Printer". From the menu, click "Troubleshoot".

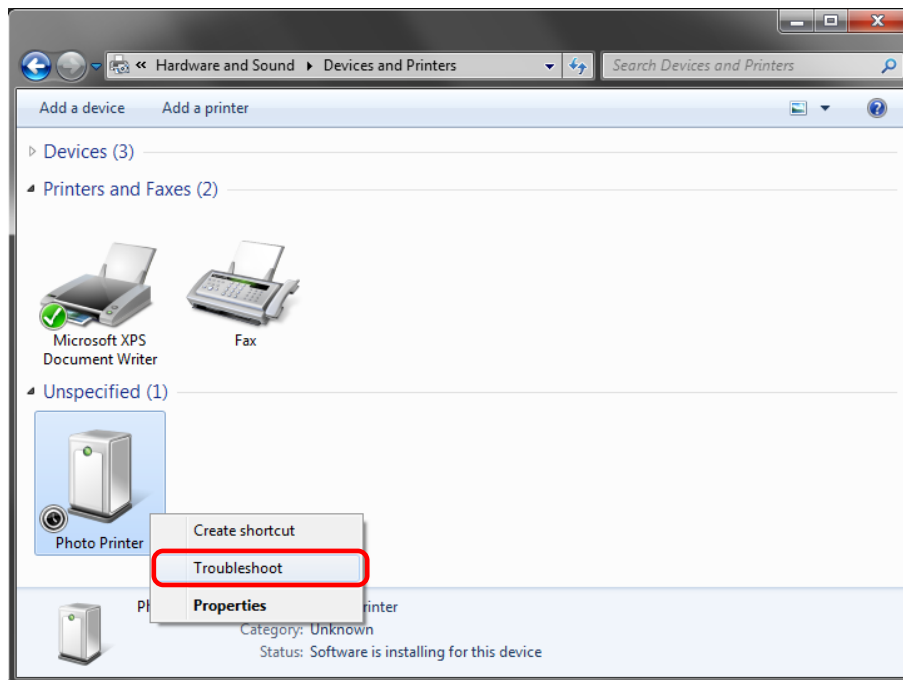

Figure 1.4.1 Photo Printer under Unspecified

The Install a driver for this device screen appears. Click "Apply this fix".
The computer searches for a driver automatically, and then installs it.

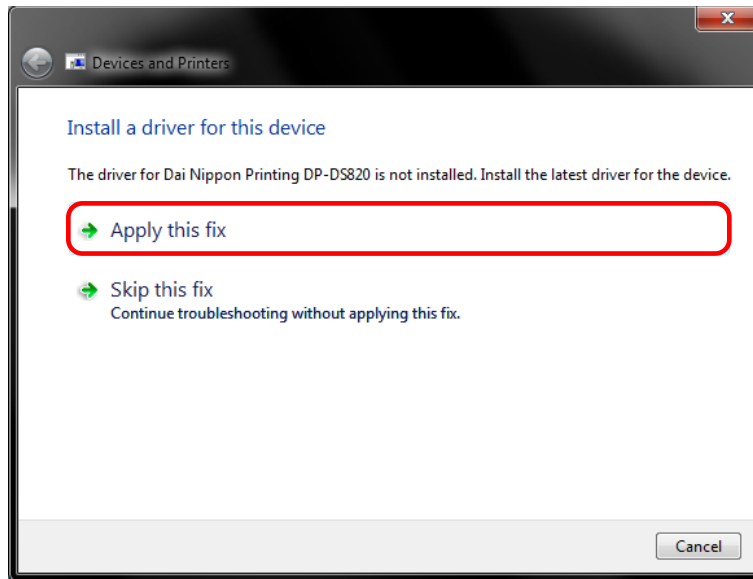

Figure 1.4.2 Applying a fix

If the driver is installed, the message "Troubleshooting has completed" appears. Click "Close the troubleshooter" to close the troubleshooting window.

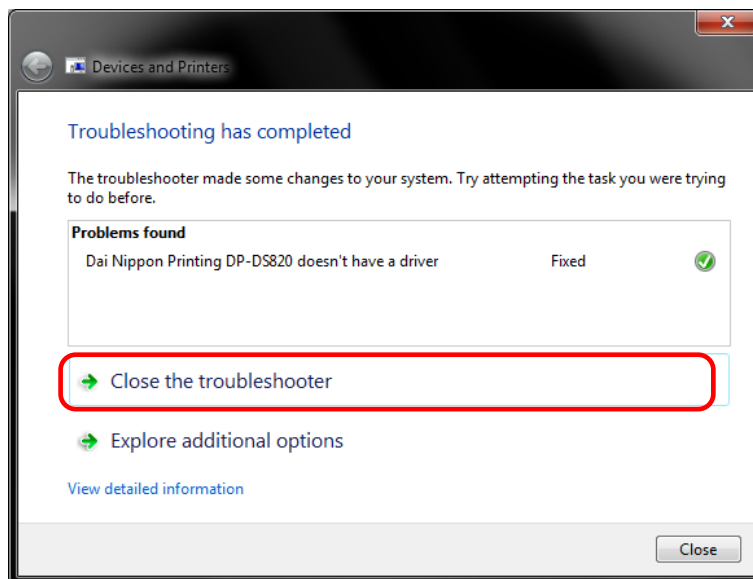

Figure 1.4.3 Completing troubleshooting

In Devices and Printers, make sure that "DP-DS820" is present.

Note: In Windows 8 and 10, when the printer is offline (the printer is not on and connected), the DP-DS820 icon is not displayed.

This completes installation of the DP-DS820 printer driver.

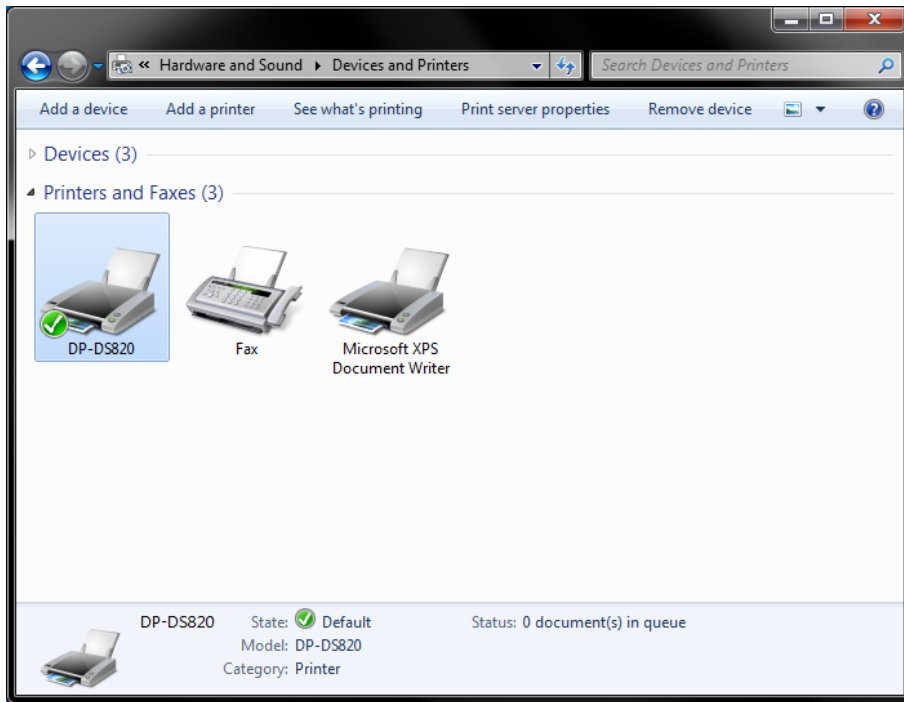

Figure 1.4.4 Devices and Printers screen

After the installation of the printer driver is complete, always restart the computer.

Chapter 2 Properties

You can configure various printer settings from the Properties of the DP-DS820 driver. Make sure you understand the contents well before changing settings. To use the properties, log in as an administrator. Depending on the application you are using, you must perform this operation from the print settings of the application.

2.1 Open the printer properties

1. Click "Start", and then click "Control Panel" to open the Control Panel.

In Windows 8, right click the Start screen, click "All Apps", and then click "Control Panel" to open the Control Panel.

In Windows 10, right click the Start, and then click "Control Panel" to open the Control Panel.

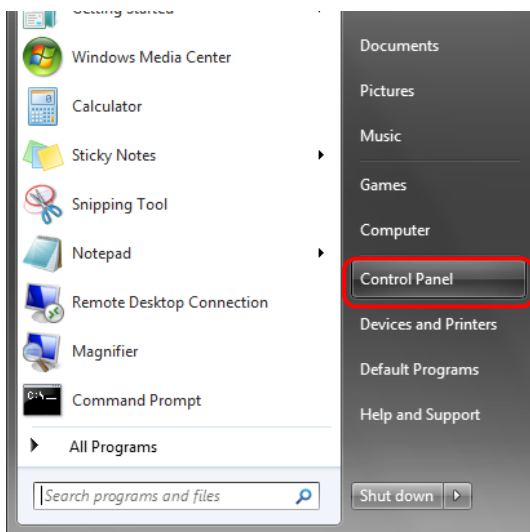

2. From the Control Panel, click "View devices and printers" to open the Devices and Printers screen.

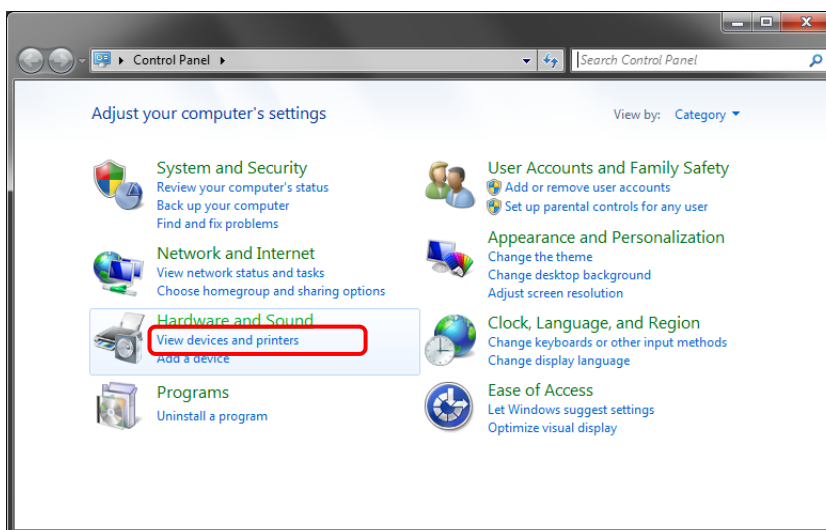

3. Right click "DP-DS820" icon. From the menu, click "Printer Properties" to open the Properties dialog box.

Note: In Windows 8 and 10, when the printer is offline (the printer is not on and connected), "DP-DS820" icon is not displayed.

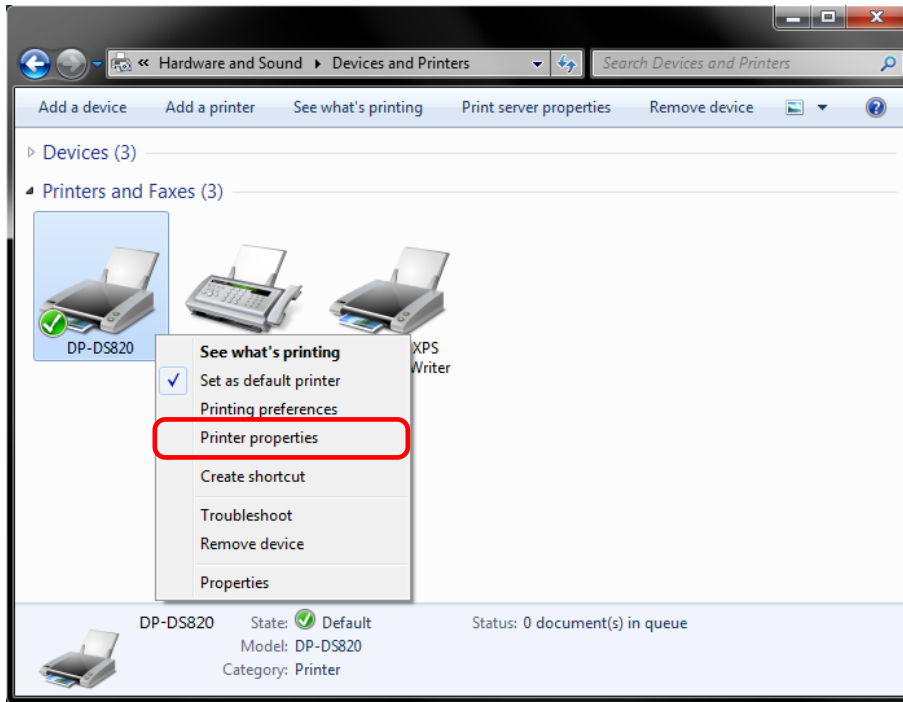

4. The DP-DS820 Properties screen appears.

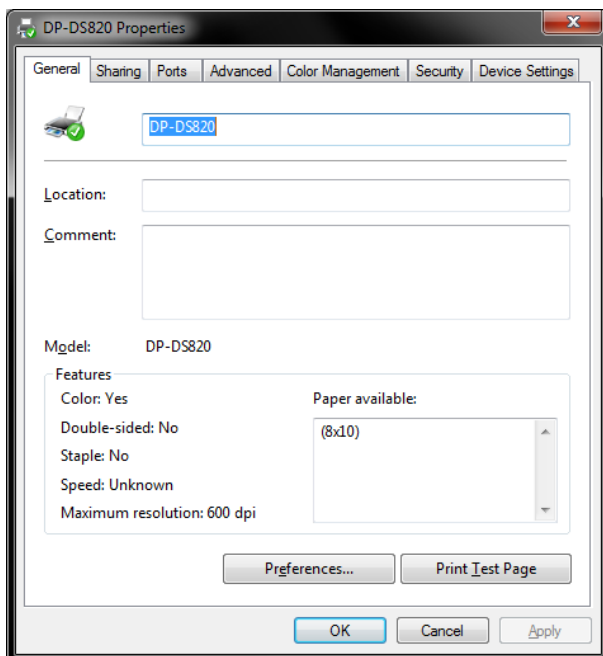

2.2 Print settings functions

If you select the basic settings from the Properties screen, you can change various print settings.

2.2.1 Layout

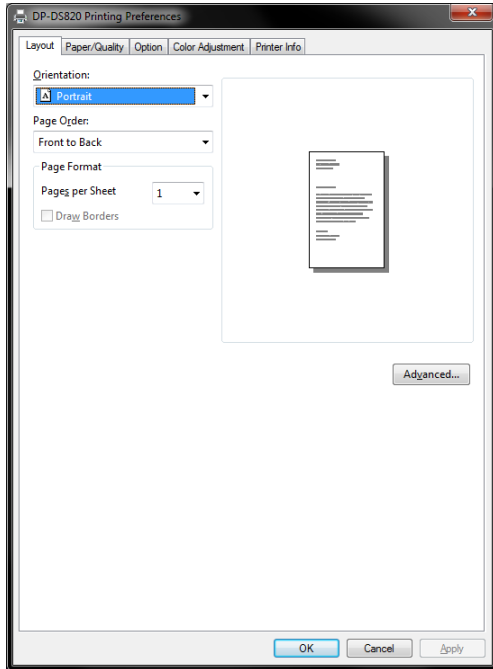

Figure 2.2.1 Layout tab

Orientation

Set the print orientation to "Portrait" or "Landscape".
For details, refer to "2.6 Orientation".

Page Order

In the application, specify the order when multiple copies of an image are printed.

Example) Print order

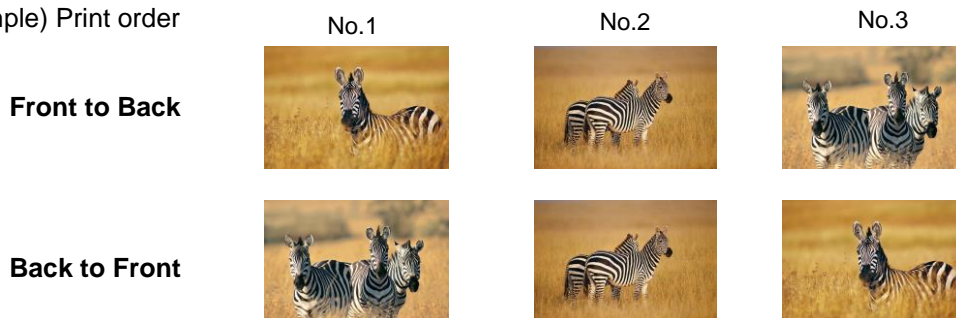

Page Format

Pages per Sheet

Set printing of the specified division size. In most situations, set "1".

Example) Division size

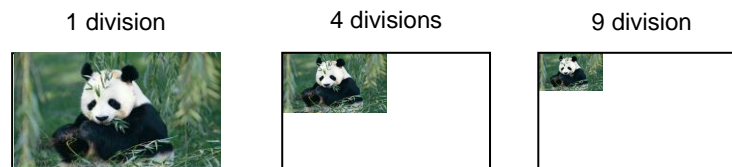

2.2.2 Advanced options

If you select "Advanced..." on the Layout tab, you can configure various advanced options.

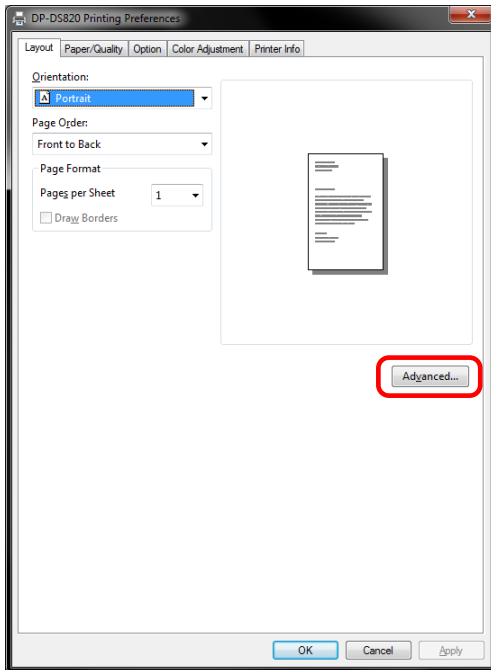

Figure 2.2.2.1 Advanced settings

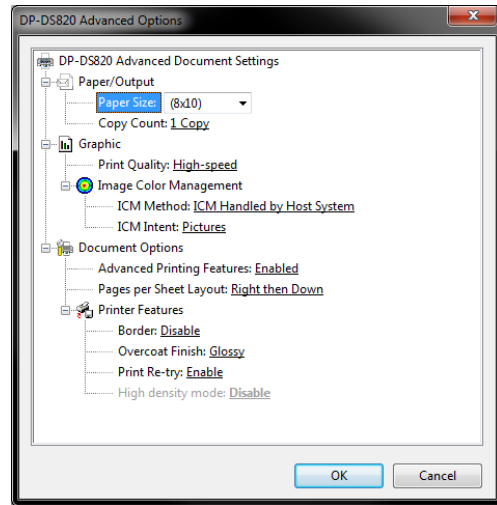

Figure 2.2.2.2 Advanced options tab

Paper/Output

Paper Size

Specify the paper size. The paper size that can be specified depends on the media size that is loaded in the printer. If the printer is offline, the loaded media size is assumed to be A4. Multiple layout will be automatically used depending on the specified paper size.

For details, see <Multiple layout> described later.

Loaded media size	Specifiable paper size	Multiple layout
8x10(*1)	8x4, 8x5	Enable
	8x6, 8x8, [8x10]	Disable
8x12(*1)	8x4, 8x5, 8x6	Enable
	8x8, 8x10, [8x12]	Disable
A4(*2)	A5 Format, 8x4, 8x5	Enable
	[A4 Format] , 8x6, 8x8, 8x10	Disable

The paper size in square brackets [] is the default paper size for the loaded media.

*1: Paper sizes that cannot be used for printing are grayed out.

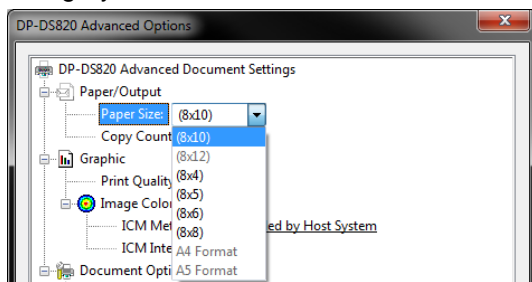

Figure 2.2.2.3 Incompatibility media size (Gray out indication)

*2: For paper sizes that can create margins on the sides of the output results, a warning appears.

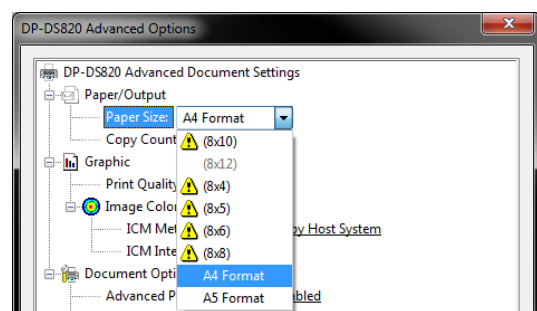

Figure 2.2.2.4 Incompatibility media size (Warning indication)

Copy Count

You can specify the number of copies to be published for images.

Graphic**Print Quality**

Specify the resolution.

Print quality	Function
High-speed	Print using high speed mode
High-quality	Print using high quality mode

ICM Method

ICM Method	Function
ICM Disabled	Synchronized with "Color Adjustment Disabled" in the 2.2.4 Option.
ICM Handled by Host System	Synchronized with "Color Adjustment ICM" in the 2.2.4 Option. Manage colors using the driver.
ICM Handled by Printer	When this item has been selected, operation is the same as "ICM Handled by Host System".

ICM Intent

Set the rendering method when using ICM. For the ICC profile, always set to "Pictures". Do not use other settings.

Document Options**Advanced Printing Features**

Always set Enable. Do not use other settings.

Pages per Sheet Layout

Set the layout direction of an image when the Pages per Sheet setting is set for multiple divisions.

Printer Features**Border**

Synchronized with Border in the Option.

Overcoat Finish

Set the overcoat finish method for the surface of printed items from the following four types.

Overcoat Finish	Function
Glossy	Create an item with a glossy finish.
Luster	Create printouts with rough surface and semi-gloss finish that has less glare.
Matte	Create an item with a matte finish.
Fine Matte	Create printouts with fine grain and strong matte finish.

Print Re-try

Specify whether to print data in the printer buffer after a printer error has been cleared.

Print Re-try	Function
Disable	Clear the print data in the printer buffer when a printer error occurs. You must send the cleared print data again after the error is cleared. When you use an application with an error recovery function, select this option.
Enable	Save print data in the printer buffer when an error occurs. The printing process is restarted from the saved data after the error is cleared. Note that if the power is switched off, the data is not saved.

Depending on the printer error, print data in the print buffer will be cleared, regardless of the Print Re-try setting.

The following section shows the operation for each Print Re-try setting by error.

Error content	When Print Re-try is disabled	When Print Re-try is enabled
Paper end	You must send the unprinted image data again after the error is cleared.	The printing process is restarted from the data saved in the printer buffer after the error is cleared. When the paper initialization operation is to be carried out, printing occurs afterwards.
Ribbon end		
Door open		
No scrap box		
Paper jam	To prevent the occurrence of an error, printing will not be restarted, regardless of the Print Re-try function setting. After the printer stops due to an error, follow the user's manual of the printer to eliminate the cause of the paper or ribbon error. You must send the unprinted image data again after the error is cleared.	
Ribbon error		
Paper size setting error		
System error · Data error · Head voltage error · Head position error · Power supply fan stopped · Cutter error · Head temperature error · Media temperature error · RFID module error	Because the printer must be switched on and off to clear the error, the print data in the printer buffer is cleared regardless of the Print Re-try setting. After the printer has restarted, you must send the unprinted image data again.	

High density mode

Enables or disables high density mode.

This function is valid only when Print Quality is "High-quality".

High density mode	Function
Disable	Prints with normal density.
Enable	Prints with an optical density higher than the maximum density. (*1)

*1: Printing time increases over printing with normal density, and the Rewind Print function is also disabled.

< Multiple layout >

Multiple layout can be specified in the paper size settings of the printer driver. When multiple images are sent from the application, multiple layout is automatically used by the printer driver.

Loaded media	Paper size setting	Paper size width x height (mm)	Maximum allocation counts
8x10	(8x4)	207.3x104.6	2
	(8x5)	207.3x130.0	2
8x12	(8x4)	207.3x104.6	3
	(8x5)	207.3x130.0	2
	(8x6)	207.3x155.4	2
A4	A5 Format	214.0x151.5	2
	(8x4) (*1)	207.3x104.6	2
	(8x5) (*1)	207.3x130.0	2

Multiple layout is carried out under the following conditions.

1. Set the paper size of the printer driver to one of the abovementioned paper sizes.
2. Send multiple images from the application. (*2)

Note)

- *1 : Margins can be created on the sides of the output results.
- *2 : Depending on usage, rewind printing may be used instead of multiple layout printing. Because they are carried out by the print job, multiple layout are carried out when there are multiple images in a single job. If you want to layout the same image, send the same number of images as the number-of-sheets setting. The printer prints two or three screens worth of images at one time and cuts the paper to the set size when the paper is ejected.

< Multiple layout patterns >

The following combinations are possible for the multiple layout patterns.

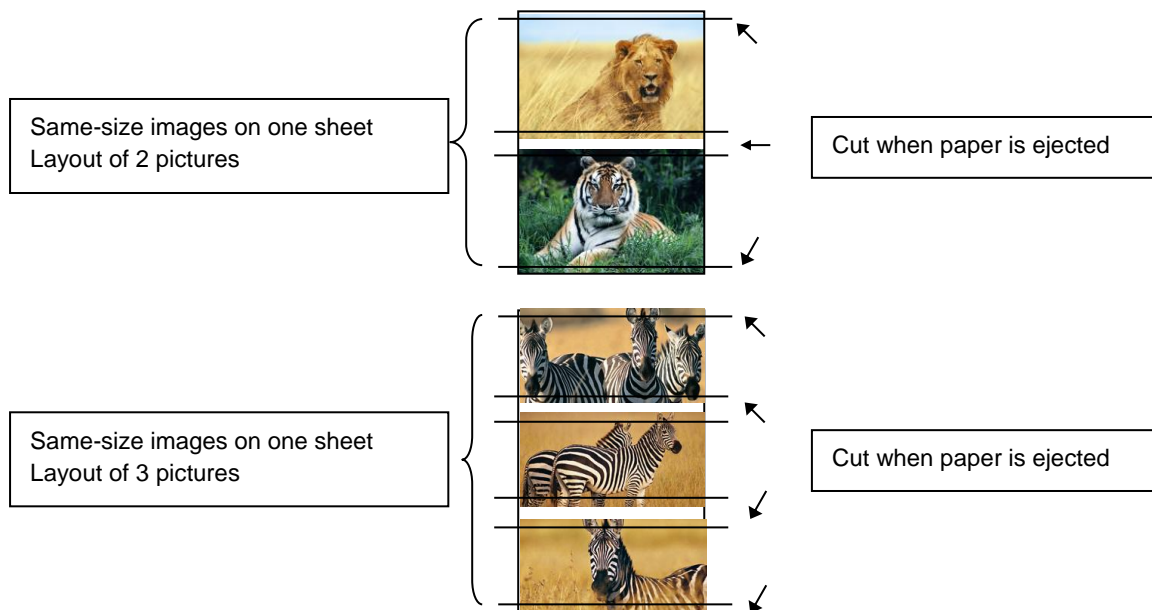



< The rewinding print function >

This function performs optimal printing that controls ribbon consumption when printing 8x4 and 8x5 size prints on 8x10 size media.

In the same manner, it also performs optimal printing that controls ribbon consumption when printing 8x4, 8x5, and 8x6 size prints using 8x12 size media, and A5 Format, 8x4, and 8x5 size prints using A4 size media.

The above operation applies only to the DP-DS820. The DP-DS820 (A) performs printing without rewinding the ribbon.

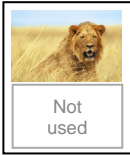
The following shows the difference in ribbon consumption when (8x4) is specified for the paper size setting for 8x10 size media.

	DP-DS820	DP-DS820 (A)
When printing one sheet at 8 x 4 size once	 <p>*After printing, the ribbon is rewound and adjusted to the next print position.</p>	
When printing one sheet at 8 x 4 size twice	 <p>*After the first sheet is printed, the ribbon is rewound, and the second sheet is printed.</p>	
When printing two sheets at 8 x 4 size once	 <p>*Two sheets are printed at the same time in a multiple layout.</p>	 <p>*Two sheets are printed at the same time in a multiple layout.</p>
When printing one 8 x 4 size sheet once, and then printing two 8 x 4 size sheets once	 <p>*After the first sheet is printed, the ribbon is rewound, and the second and following sheets are printed. Furthermore, after the third sheet is printed, the ribbon is rewound and adjusted to the next print position.</p>	 <p>*For the second and third sheets, two sheets are printed at the same time in a multiple layout.</p>

< Application usage example >

This usage example uses Windows Explorer.

Step 1. In Windows Explorer, select two or more pictures.

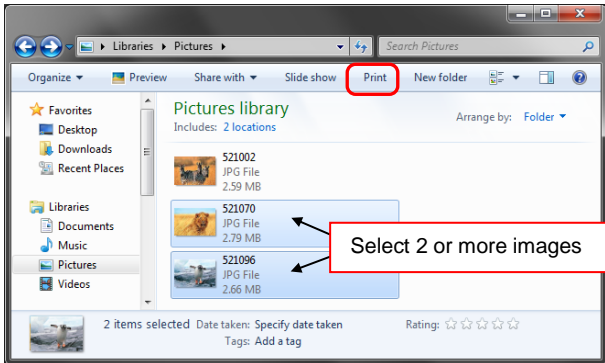

Step 2. Select "Fit picture to frame" check box, and then click "Options...".

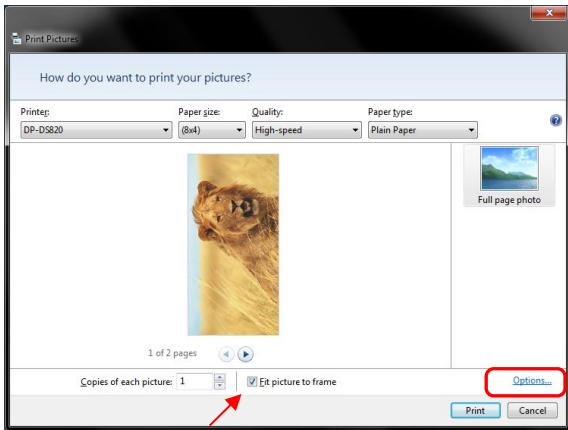

Step 3. Click "Printer Properties...".

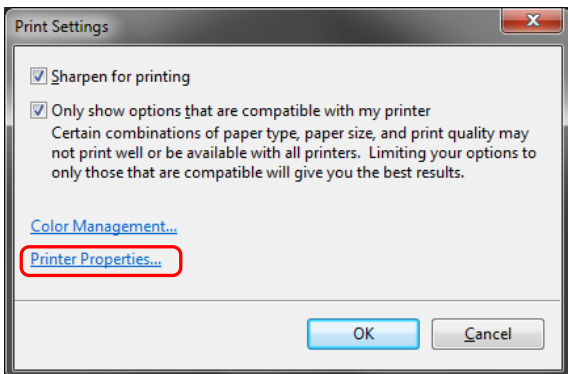

Step 4. Set the Orientation to Portrait, and click "Advanced...".

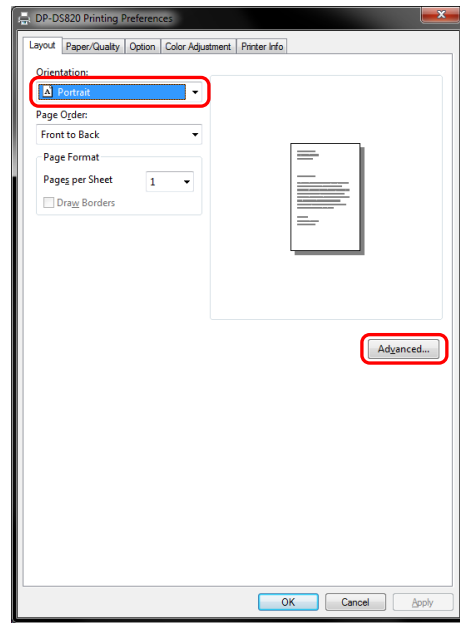

Step 5. Set the paper size to the setting of the multiple layout.

Click OK twice to close the dialog boxes in Step 5 and 4.

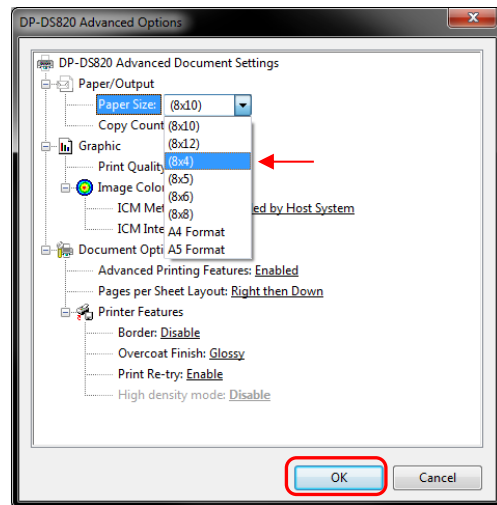

Step 6. Click the Print button.

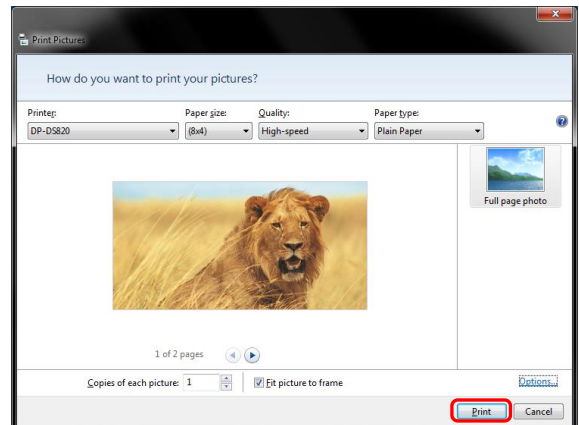

2.2.3 Paper/Quality

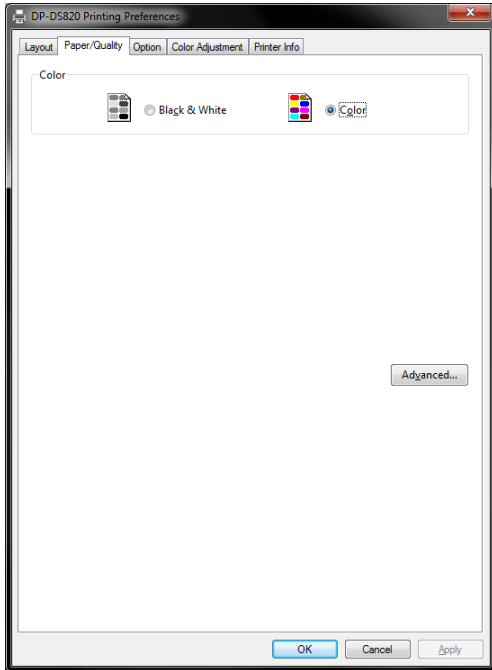

Figure 2.2.3 Paper/Quality tab

Color Set Color. Do not use black and white.

2.2.4 Option

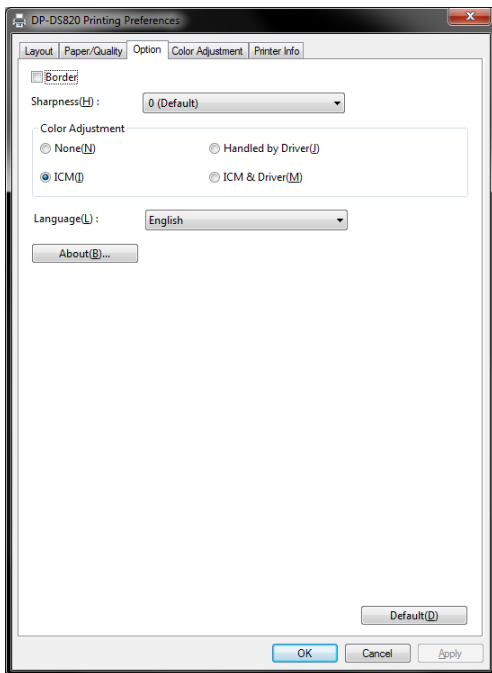

Fig 2.2.4.1 Option tab

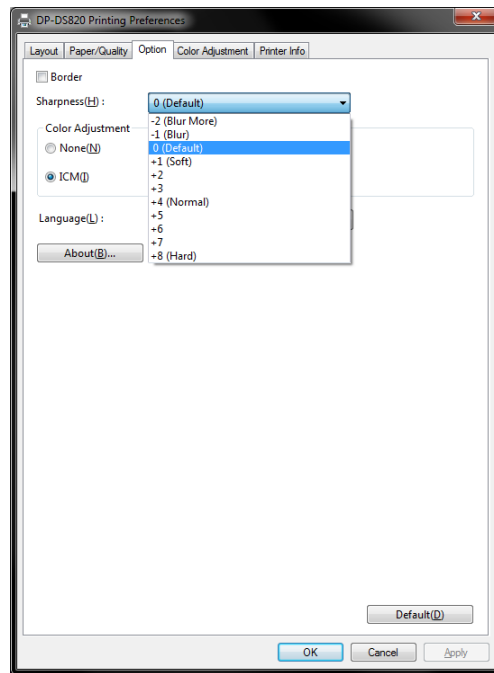

Fig 2.2.4.2 Sharpness setting

Border

Specify a border for printing. (Select the check box for a border.) Synchronized with Border Enable/Disable in the Advanced settings.

Sharpness

Process sharpness using one of the 11 stages (Figure 2.2.4.2). If the setting is "0 (Default)", sharpness is not processed.

Moving to the minus (-) side blurs the image and moving to the plus (+) side sharpens the image.

Color Adjustment**None**

Synchronized with the ICM Method in the Advanced settings. If this check box is selected, ICM is disabled, the Color adjustment tab is also disabled, and the printer driver does not carry out color adjustment.

Handled by Driver

If this check box is selected, ICM is disabled, and the 2.2.5 Color Adjustment is enabled. The result is applied to the adjustment values of the following items: Gamma, Brightness, Contrast, and Chroma.

ICM

Synchronized with the ICM Method of the Advanced settings (ICM Handled by Host System). If this check box is selected, the driver manages colors.

ICM & Driver

If this check box is selected, ICM (color management) and the 2.2.5 Color Adjustment are enabled.

Language

Change the display language for the following items: Advanced options-Printer functions, Option, Color Adjustment, and Printer Info.

The selected language is enabled the next time the print settings are displayed.

[Available languages]

- Japanese
 - English (US)
 - French (France)
 - German (Germany)
 - Russian (Russia)
 - Spanish (Spain)
 - Korean
 - Chinese (People's Republic of China)
 - Chinese (Taiwan)
- When your operating system environment corresponds with one of the above settings, the default display language is the language of the corresponding country.
Furthermore, when your operating system environment does not correspond with one of the above settings, the default display language is English.
 - To use a language different from that of your operating system, you must install the following font for the corresponding language.

Language	Font
Japanese	Meiryo / Yu Gothic UI <Windows10>
English (US)	Segoe UI
French (France)	Segoe UI
German (Germany)	Segoe UI
Russian (Russia)	Segoe UI
Spanish (Spain)	Segoe UI
Korean	Malgun Gothic
Chinese (People's Republic of China)	Microsoft YaHei
Chinese (Taiwan)	Microsoft JhengHei

About

Show the driver version.

2.2.5 Color Adjustment

If the Handled by Driver check box is selected in the 2.2.4 Option, the adjustment values of the Color Adjustment tab are applied to the image.

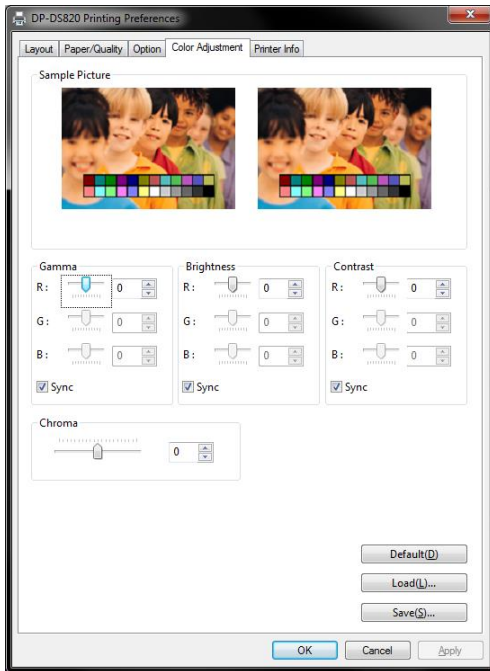

Fig 2.2.5 Color Adjustment tab

The following section shows the setting ranges on the Color Adjustment tab.

Adjustment item	Adjustment value
Gamma	-100 (dark) to 100 (bright) ("0" results in no adjustment, $\gamma 2.0$ to 0.5) Adjust the density of the half-tone section of the image. Increasing the gamma value brightens the half-tone section. Sync check box ON: Set RGB to same value. OFF: Set RGB to different value.
Brightness	-100 (dark) to 100 (bright) ("0" results in no adjustment) Adjust the brightness of the image. Increasing the brightness value brightens the entire image. Sync check box ON: Set RGB to same value. OFF: Set RGB to different value.
Contrast	-100 (weak) to 100 (strong) ("0" results in no adjustment) Adjust the contrast of the image. Increasing the contrast value increases the difference of brightness and darkness. Sync check box ON: Set RGB to same value. OFF: Set RGB to different value.
Chroma	-100 (weak) to 100 (strong) ("0" results in no adjustment) Adjust the chroma of the image.

2.2.6 Printer information

View the printer information.

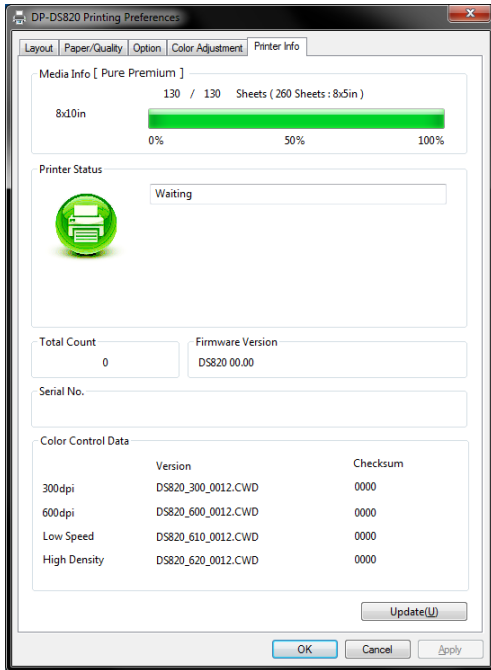

Fig 2.2.6.1 Printer Information tab

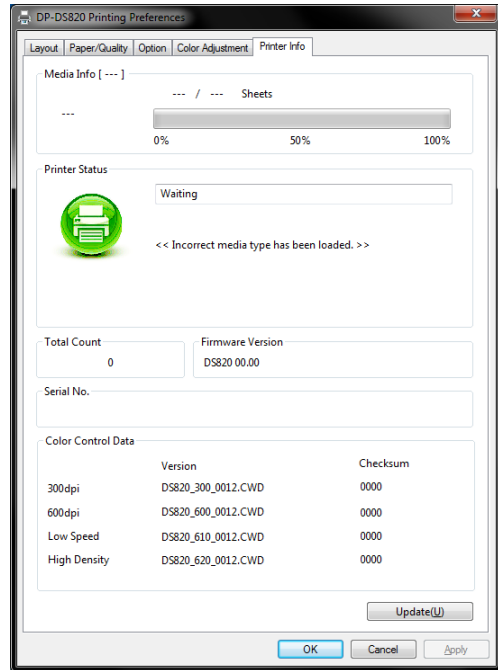























Figure 2.2.6.2 Display when incorrect media is loaded

The following section shows the information displayed in the Printer Info tab.

Display item	Display details																		
Media Info	This area shows, for example, the class, the size, and the remaining number of printable sheets for the ribbon media in the printer. * Media information is not displayed when a media type not supported by the printer has been loaded. (Figure 2.2.6.2)																		
Printer Status	Displays the status of the printer using icons and characters. <table border="1" style="width: 100%; border-collapse: collapse;"> <thead> <tr> <th>Display icon (Color)</th> <th>Display characters</th> <th>Status/Response</th> </tr> </thead> <tbody> <tr> <td style="text-align: center;"> (Green)</td> <td>Waiting</td> <td>Printing is possible.</td> </tr> <tr> <td style="text-align: center;"> (Blue)</td> <td>Printing</td> <td>The printer is printing.</td> </tr> <tr> <td style="text-align: center;"> (Yellow)</td> <td>Door open</td> <td>Front door is open. Close the front door.</td> </tr> <tr> <td style="text-align: center;"> (Yellow)</td> <td>Ribbon end</td> <td>No ribbon remains. Load new media. (Replace the paper and ribbon as a set.)</td> </tr> <tr> <td style="text-align: center;"> (Yellow)</td> <td>Paper end</td> <td>No paper remains. Load new media. (Replace the paper and ribbon as a set.)</td> </tr> </tbody> </table>	Display icon (Color)	Display characters	Status/Response	 (Green)	Waiting	Printing is possible.	 (Blue)	Printing	The printer is printing.	 (Yellow)	Door open	Front door is open. Close the front door.	 (Yellow)	Ribbon end	No ribbon remains. Load new media. (Replace the paper and ribbon as a set.)	 (Yellow)	Paper end	No paper remains. Load new media. (Replace the paper and ribbon as a set.)
Display icon (Color)	Display characters	Status/Response																	
 (Green)	Waiting	Printing is possible.																	
 (Blue)	Printing	The printer is printing.																	
 (Yellow)	Door open	Front door is open. Close the front door.																	
 (Yellow)	Ribbon end	No ribbon remains. Load new media. (Replace the paper and ribbon as a set.)																	
 (Yellow)	Paper end	No paper remains. Load new media. (Replace the paper and ribbon as a set.)																	

Display item	Display details		
Printer Status	Display icon (Color)	Display characters	Status/Response
	 (Gray)	Offline	The printer cannot be recognized. Connect the printer and computer, and then turn on the power.
	 (Purple)	Cooling head	The head is being cooled. Please wait a while. Printing will resume automatically.
	 (Orange)	Ribbon error	The ribbon is not set correctly. Reload the ribbon properly.
	 (Orange)	Paper size setting error	The printer settings and size of the installed ribbon do not match. Check the paper size setting and ribbon size.
	 (Orange)	Paper jam	A paper jam was detected. Remove the paper and reload it properly.
	 (Orange)	No scrap box	The scrap box is being detached. Attach the scrap box.
	 (Red)	System error	System error. Restart the printer and computer. If the printer does not recover after the restart, contact the service center.
* A warning message is displayed when a media type not supported by the printer has been loaded.(Figure 2.2.6.2)			
Total Count	Total count of printed sheets.		
Firmware Version	Version of the control program of the printer. xx.xx indicates the version. <ul style="list-style-type: none"> • DS820A xx.xx (For the United States) • DS820 xx.xx (For other countries) 		
Serial No.	Serial number of the printer.		
Color Control Data	Printer color control data.		

2.3 Default values for settings

The following section shows the default values of the settings (at installation). If the settings have been changed, and the printer driver no longer operates normally, return to the default values shown below.

Note) Depending on the service pack of your operating system or your usage environment, the default values at installation may differ from those in the chart below.

Chart 2.3 Default print settings

Tab	Setting		Value	
Layout	Orientation		Portrait	
	Page Order		Front to Back	
	Pages Per Sheet		1	
Paper/Quality	Color		Color	
Option	Border		Disable	
	Sharpness		0 (Default)	
	Color Adjustment		ICM	
	Language setting		English	
Color Adjustment	Gamma		0	
	Brightness		0	
	Contrast		0	
	Chroma		0	
Advanced settings (In the Layout tab, click "Advanced...")	Paper/Output	Paper Size	Depends on printer media size (*1)	
		Copy Count	1	
	Graphic	Print Quality		High-speed
		Image color management	ICM Method	ICM Handled by Host System
			ICM Intent	Pictures
	Document options	Advanced Printing Features		Enable
		Pages per Sheet Layout		Right then Down
		Printer function	Border	Disable
			Overcoat Finish	Glossy
			Print Re-try	Enable
	High density		Disable	

*1: For the initial values of paper sizes, see "2.2.2 Advanced options".

2.4 Color management

Use Color management to specify the color profile. The installer associates "SD_DS820_0010.icc" and "PP_DS820_0010.icc" by default.

This printer driver automatically changes the color profile for the media that is loaded in the printer.

To use an ICC profile other than the default profile, overwrite the ICC profile that has been registered as the default.

For the ICC profile to overwrite, prefix "SD_" to the profile name for Digital media and prefix "PP_" to the profile name for Pure Premium media.

Example: Overwritten profile name

- For Digital : SD_xxxxxxx.icc
- For Pure Premium : PP_xxxxxxx.icc

Step 1. From the Printer Properties, select the Color Management tab, and then click "Color Management...".

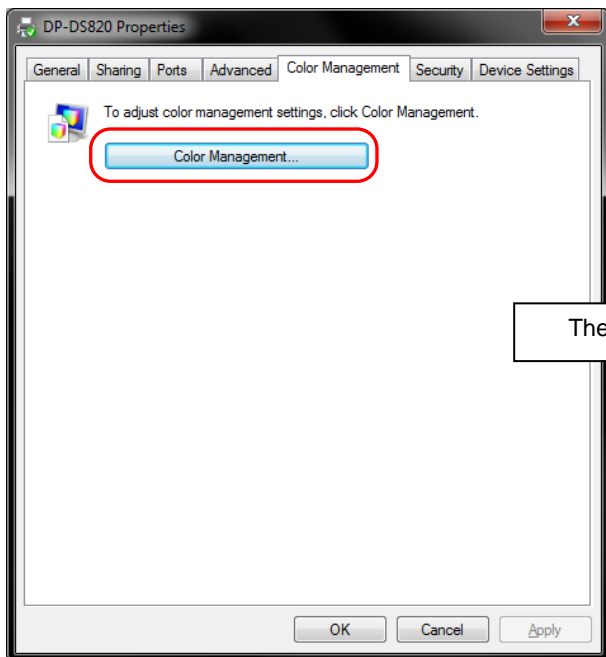

Fig 2.4.1 Color Management Tab

Step 2. From Device, select DP-DS820.

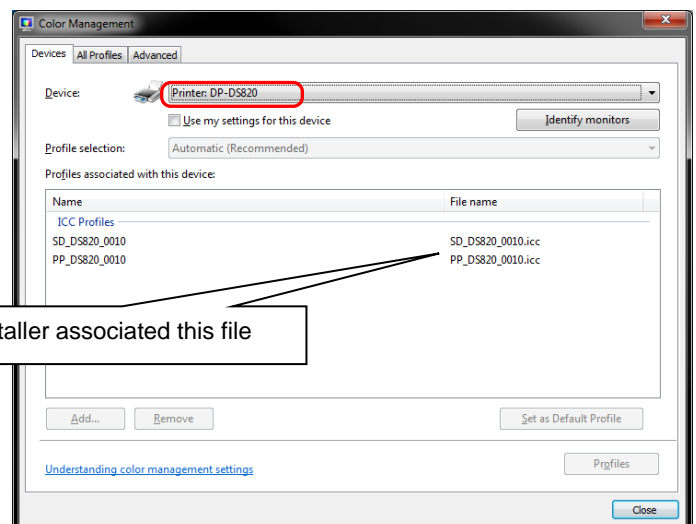

Fig 2.4.2 Color Management Window

2.5 Print Area



The following section shows the image sizes and numbers of dots generated by the paper size setting of the driver.

Paper size	Image size (width x height)		Number of image dots (width x height)	
	(inch)	(mm)	High-speed (300x300dpi)	High-quality (600x600dpi)*1
(8x4)	8"x 4"	207.3 x 104.6	2448 x 1236	4896 x 2472
(8x5)	8"x 5"	207.3 x 130.0	2448 x 1536	4896 x 3072
(8x6)	8"x 6"	207.3 x 155.4	2448 x 1836	4896 x 3672
(8x8)	8"x 8"	207.3 x 206.0	2448 x 2436	4896 x 4872
(8x10)	8"x 10"	207.3 x 257.0	2448 x 3036	4896 x 6072
(8x12)	8"x 12"	207.3 x 307.8	2448 x 3636	4896 x 7272
A5 Format	8.3" x 5.8"	214.0 x 151.5	2528 x 1790	5056 x 3580
A4 Format	8.3" x 11.7"	214.0 x 300.0	2528 x 3544	5056 x 7088

*1: Convert to 300 x 600 dpi size within the driver, and then send to the printer.

2.6 Orientation

The following chart shows the relationship of images generated by an application and printed items (output direction) according to the orientation setting. Generated images are not the original image rotated by the application but are zoomed to fit within the sizes is shown in "2.5 Print Area".

Original image	Driver setting				
	Orientation	Paper setting		Generated image	Printed item (Output orientation ↓)
		(8x4) (8x5) (8x6) (8x8) A5 Format	(8x10) (8x12) A4 Format		
		Generated image	Printed item (Output orientation ↓)	Generated image	Printed item (Output orientation ↓)
	Portrait				
	Landscape				
	Portrait				
	Landscape				

Chapter 3 Update the driver

As when performing the installation, log in as an administrator before carrying out this operation.

1. Check the job

- 1) Before updating the printer driver, close all applications. Furthermore, click on the icon of the printer to be updated in the Devices and Printers screen. At the bottom area of the screen, confirm that there are no documents in the queue, and then start update of the driver.

Note: In Windows 8 and 10, when the printer is offline (the printer is not on and connected), the DP-DS820 icon is not displayed. Always connect the printer with the power turned on and check that there are no documents in the queue.

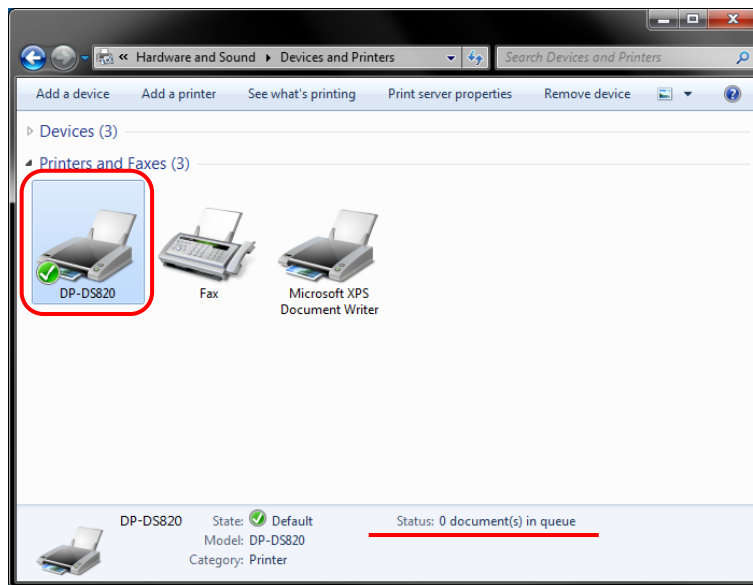

Figure 3.1 Clicking the DP-DS820 icon at the Devices and Printers screen

2. Uninstall the driver package

- 1) Click "Start", and then click "Control Panel". In the Control Panel, click "Uninstall a program".
 In Windows 8, right click the Start screen. In the bottom right area, select "All Apps", and then select "Control Panel". In the Control Panel, click "Uninstall a program".
 In Windows 10, right click the Start., and then click "Control Panel". In the Control Panel, click "Uninstall a program".

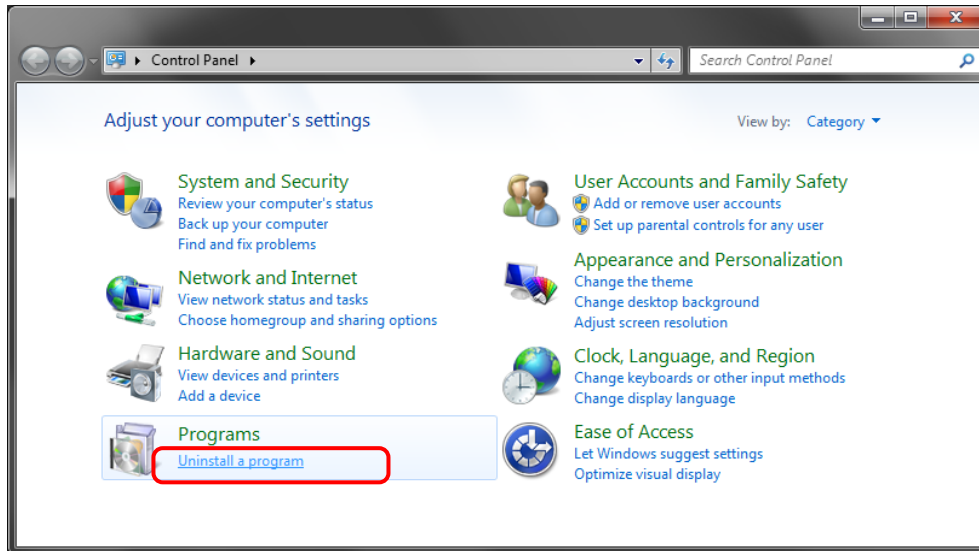

Figure 3.2 Control Panel

- 2) The Uninstall or change a program screen appears. In the list, double click "Dai Nippon Printing DP-DS820".

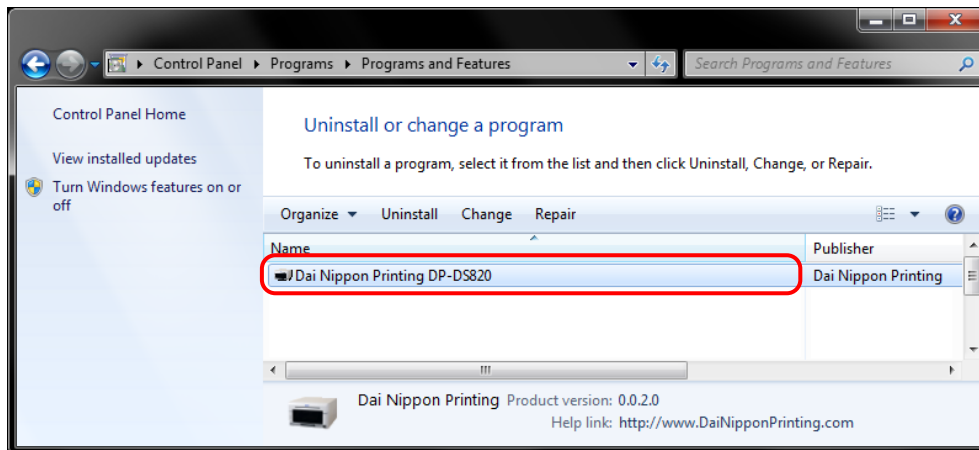

Figure 3.3 Uninstall a program

- 3) Click "Yes" when the Dai Nippon Printing DP-DS820 uninstall confirmation windows appears. Uninstalling the driver is complete. After uninstalling the printer package, restart the computer.

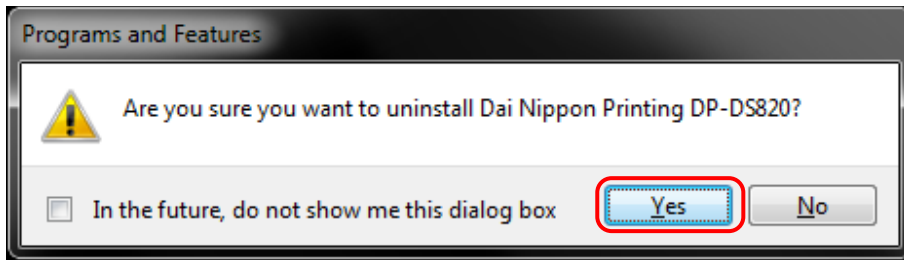

Figure 3.4 Uninstallation confirmation

When a User Account Control dialog box appears, click Yes.

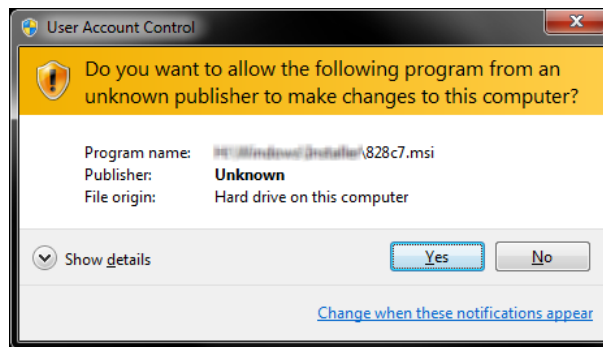

Figure 3.5 User Account Control

3. Install an upgrade for the printer driver

After deleting the printer and the printer driver, install the new printer driver. For the installation procedure, see "Chapter 1 Installation".

4. Restart the computer

After the installation of the printer driver is complete, always restart the computer. (Do not print just after installation. Always restart the computer once.)

Chapter 4 Delete the driver

4.1 Automatic deletion of printer drivers

The printer driver is automatically deleted when uninstalling the driver package.
For the steps to uninstall the driver package, see “2. Uninstall the driver package” in Chapter 3.

Note that uninstalling the driver package when the printer driver is in use will display the following message, and the printer driver will not be deleted.

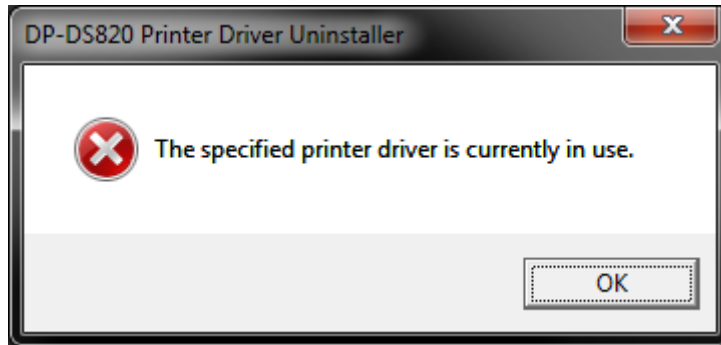

Figure 4.1 Message displayed when the driver is in use

When the above message is displayed, restart the computer and then delete the printer driver using the procedure described in “4.2 Manual deletion of printer drivers”.

4.2 Manual deletion of printer drivers

1) Click "Start", and then click "Control Panel". In Control Panel, click "Devices and Printers".

From the Devices and Printers screen, right click the DP-DS820 printer. From the menu, click "Remove device".

In Windows 8, right click the Start screen. In the bottom right area, select "All Apps", and then select "Control Panel". In the Control Panel, click "Devices and Printers".

In Windows 10, right click the Start. In the bottom right area, select "All Apps", and then select "Control Panel". In the Control Panel, click "Devices and Printers".

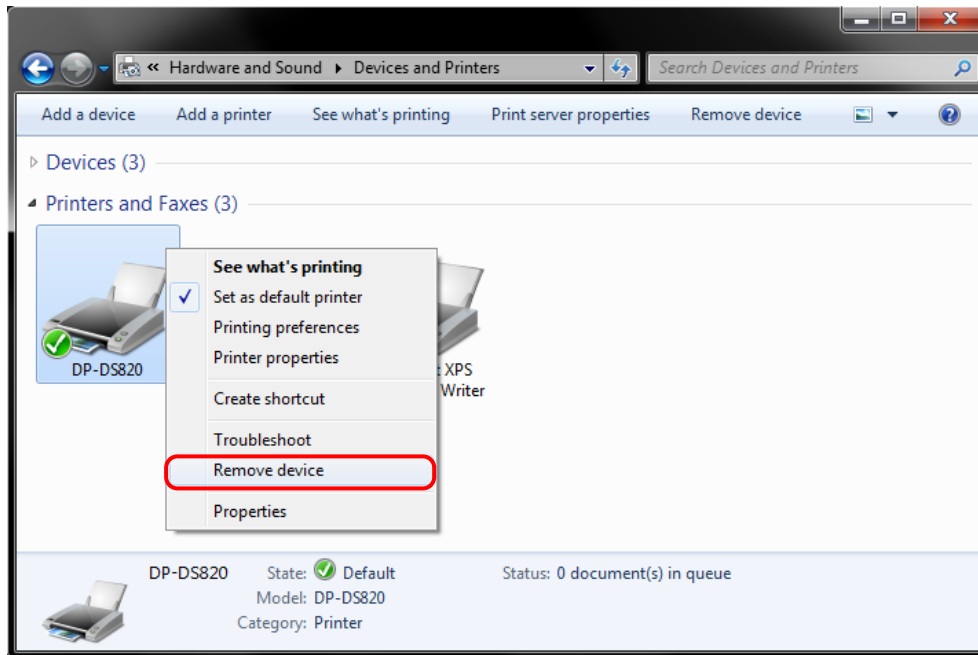

Figure 4.2.1 Right clicking DP-DS820 in the Devices and Printers screen

In Windows 8 and 10, when the printer is offline (the printer is not on and connected), the DP-DS820 icon is not displayed. In such cases, use the following procedure to delete the device.

- (i) On an empty area in the Devices and Printers screen, right click, and then select "Device Manager".

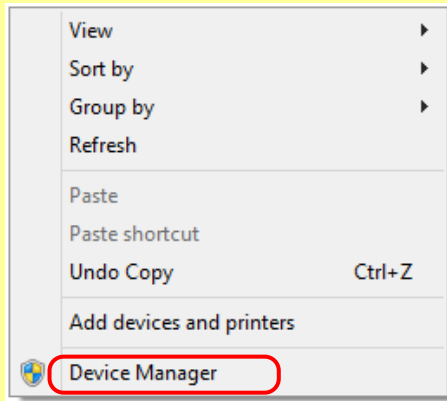

Figure 4.2.2.i Right clicking on an empty area in the Devices and Printers screen

- (ii) Click View, and then select "Show hidden devices".

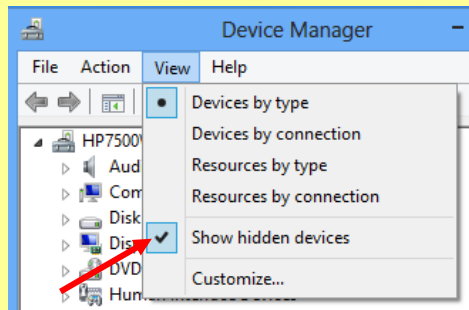

Figure 4.2.2.ii Displaying the View menu for hidden devices

- (iii) Under Printers, right click DP-DS820, and then select "Uninstall".

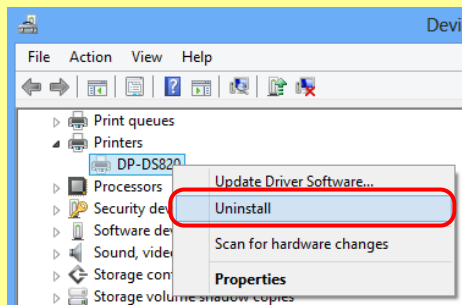

Figure 4.2.2.iii Displaying the menu to delete DP-DS820

- (iv) At the Confirm Device Uninstall screen, click OK.



Figure 4.2.2.iv Confirm Device Uninstall screen

2) The printer deletion confirmation dialog box appears. Click Yes.

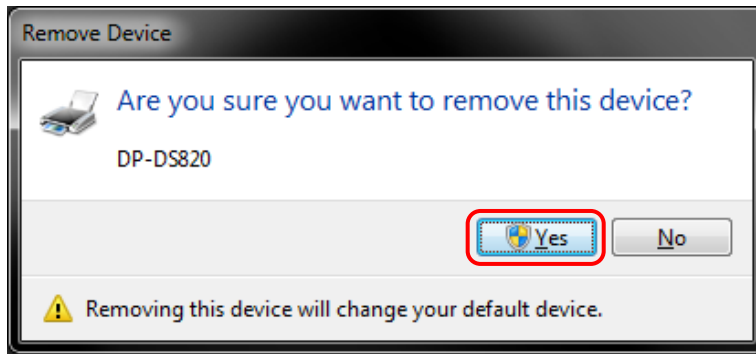

Figure 4.2.3 Printer deletion confirmation dialog box

3) After deleting the DP-DS820 printer, select another printer (for example, Fax), and then click "Print Server Properties" in the menu bar.

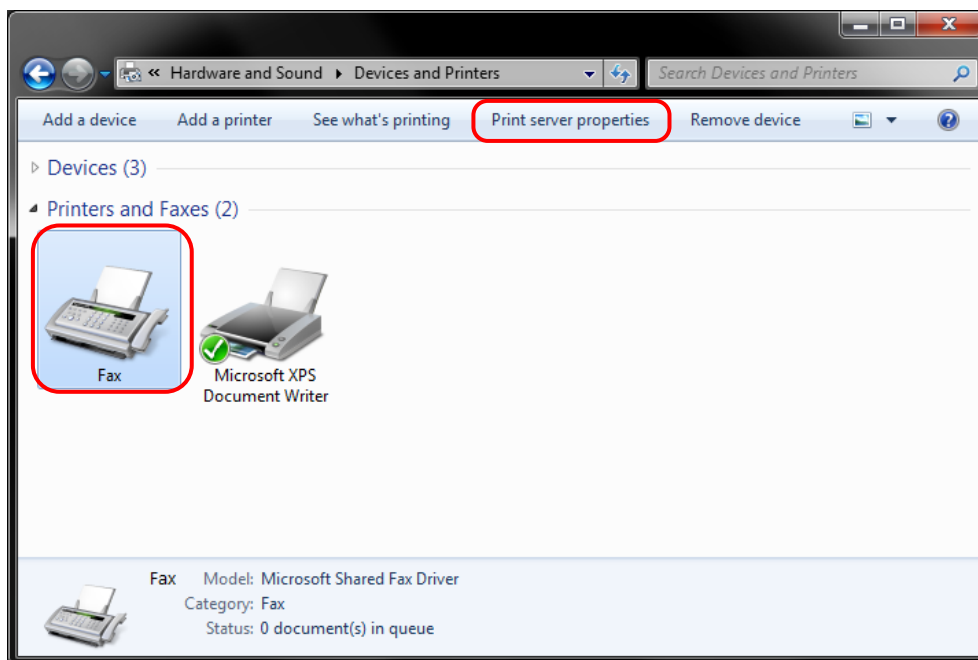

Figure 4.2.4 Displaying the Print Server Properties menu in the Devices and Printers screen

4) The Print Server Properties dialog box appears. Click the Drivers tab. From the installed printer driver list, select DP-DS820, and then click "Remove...".

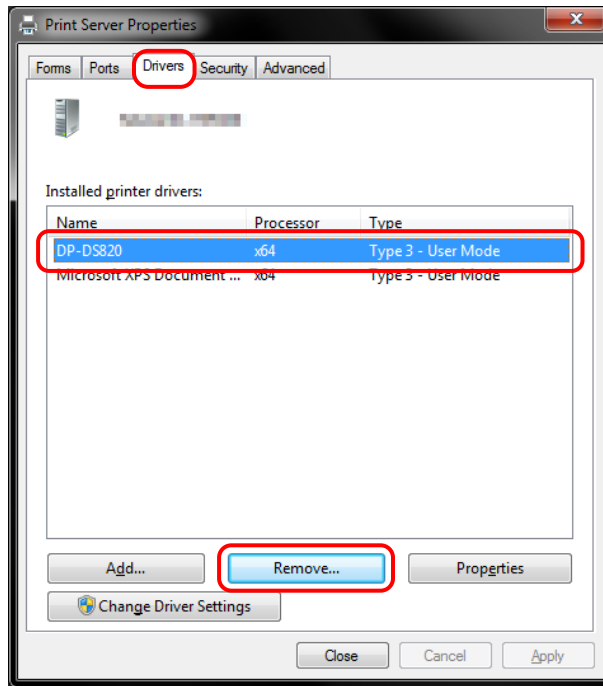

Figure 4.2.5 Printer Server Properties dialog box

5) The Remove Driver and Package dialog box appears. Select "Remove driver only", and then click OK.

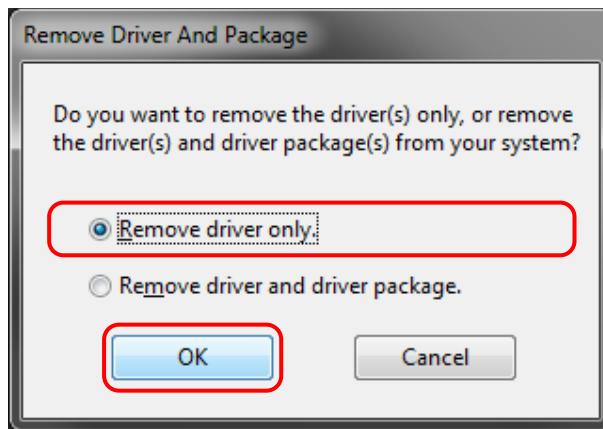

Figure 4.2.6 Remove Driver And Package dialog box

6) The Print Server Properties confirmation dialog box appears. Click Yes.

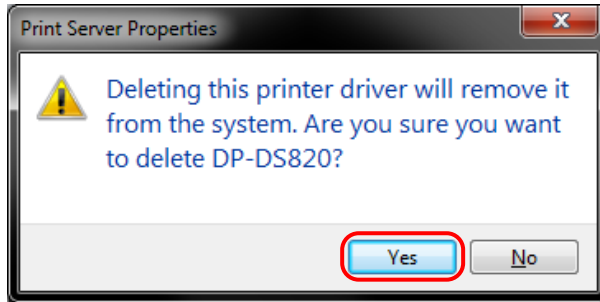

Figure 4.2.7 Driver deletion confirmation dialog box

7) In the Print Server Properties dialog box, confirm that DP-DS820 was deleted, and then click Close.

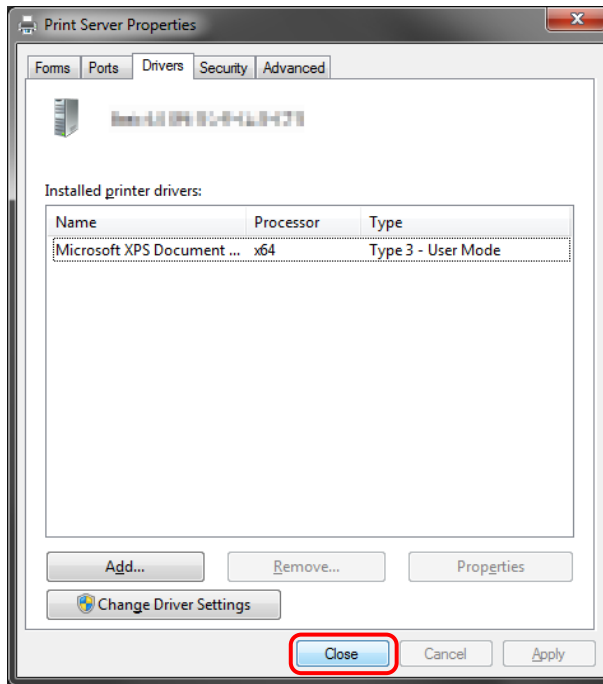

Figure 4.2.8 Print Server Properties

Dai Nippon Printing Co., Ltd.